

Kiturami

Quadplex –

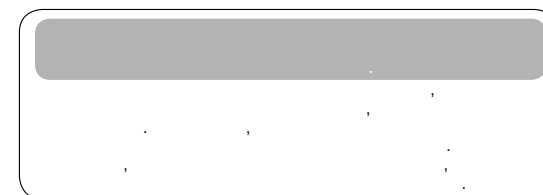

- ECO Condensing () – 16H/20H/25H/30H/35H
- ECO Condensing () – 16D/20D/25D/30D/35D





?

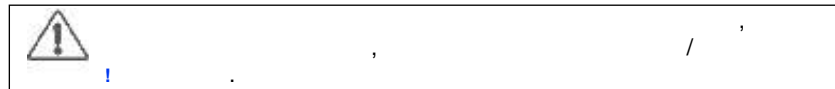

», « !», « !», « :

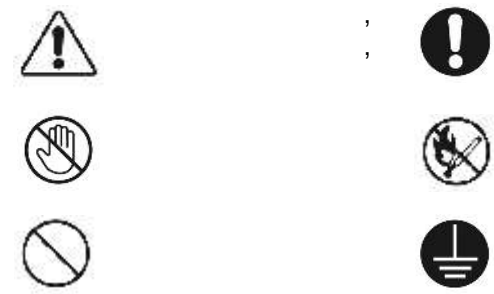

- 03
- 04
- 05
- 07
- 10
- 17
- 22
- 24
- 26
- 28
- 29
- 31
- 32
- 36
- 37
- 38
- 39
- 42
- 43
- 44
- 45
- 46
- 47

« »..

« »

» / «Outing» (« ») / «Reservation» (« ») / «DHW» (« »)

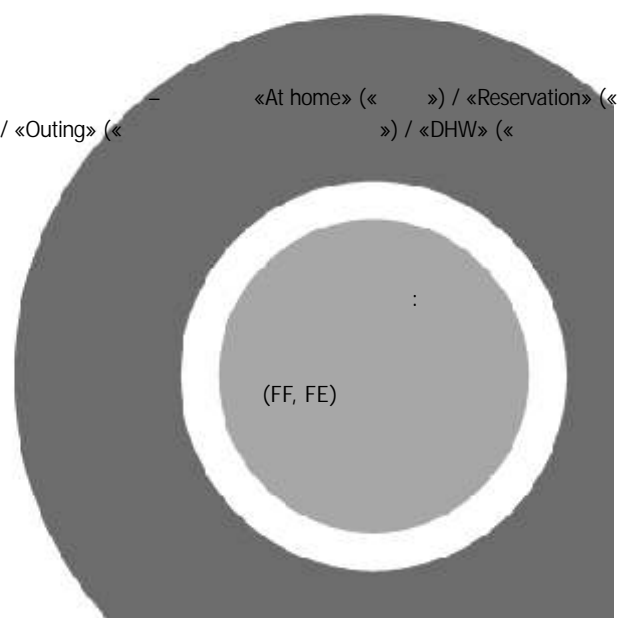

(FF, FE)



», « « », « »

(. . . 10)

« » (. . . 11, 13, 17)

(. . . 24 ~ 25)

(. . . 8, 11)

35 60

)

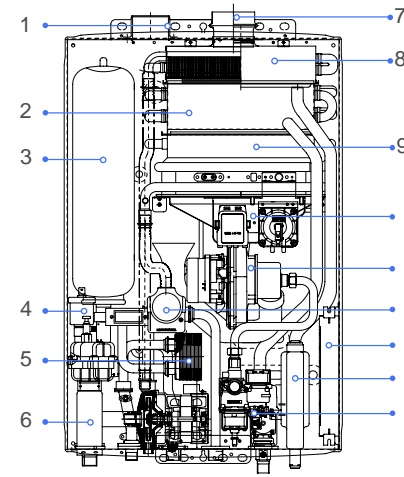
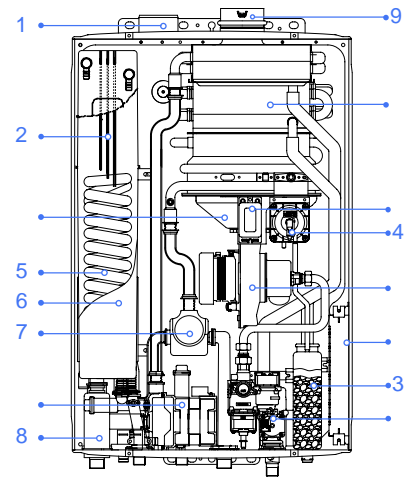

- 1 9
- 2
- 3
- 4
- 5
- 6
- 7
- 8 filter

- 1 8
- 2 9
- 3
- 4
- 5
- 6
- 7

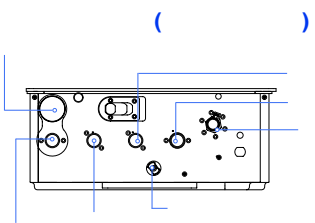
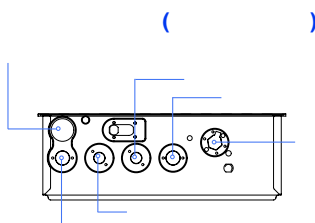

CTR-5700

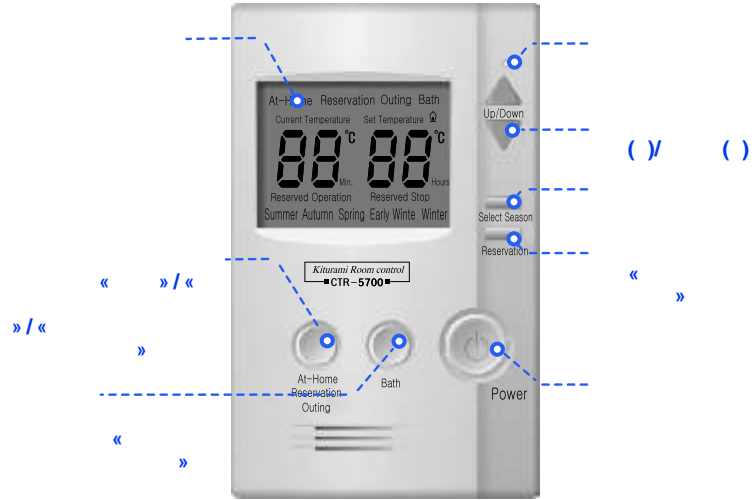

Diagram illustrating the thermostat's operation and settings. It includes a large blue box containing the following text:

(/)

(ON/OFF)

(5)

Additional text and symbols are present within the blue box, including navigation arrows and a power symbol.



Diagram illustrating a warning or error state. It includes a dashed line and a question mark.

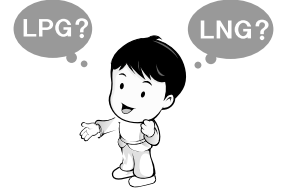

230 /50

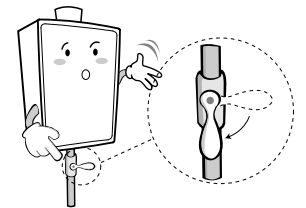
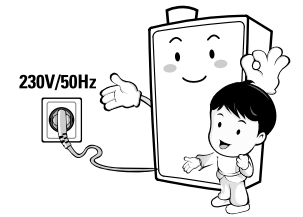



No. 95

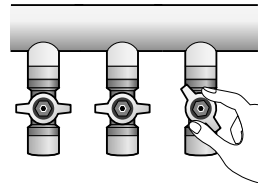
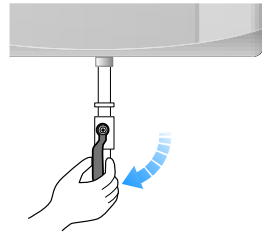

(CO).

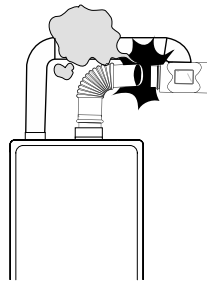

(Inflammable materials: Methane, acetylene, propane, hydrogen sulphide, water gas, coal gas, gasoline, acetone, toluene, and other combustible liquids whose flash point is below 30 .)

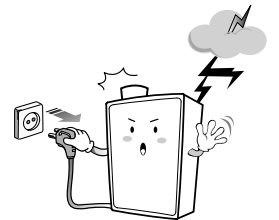



- 1.
 - 2.
 - 3.
- ?

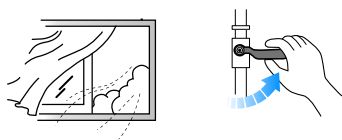

(

?)

'97'



. 19)



"95"

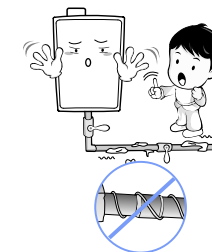



:

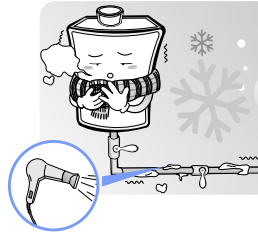

?



:



:

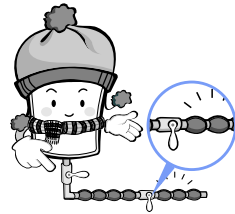

:



:

: 1

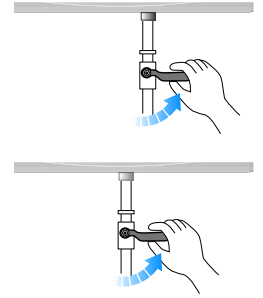

:

: 2

. (. .20)

. (, .

.)

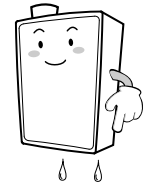

!



:

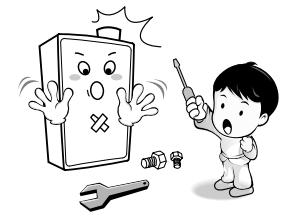



: 1



: 2

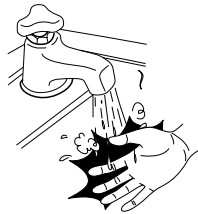

:

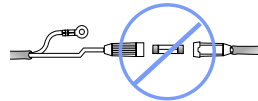

:

1-2

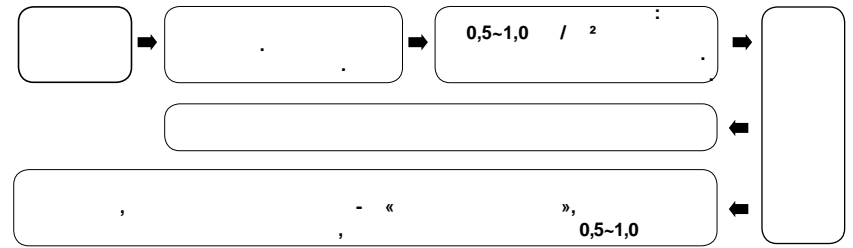

- 1.
2. (2,5),
- 3.

“95”
 (,)

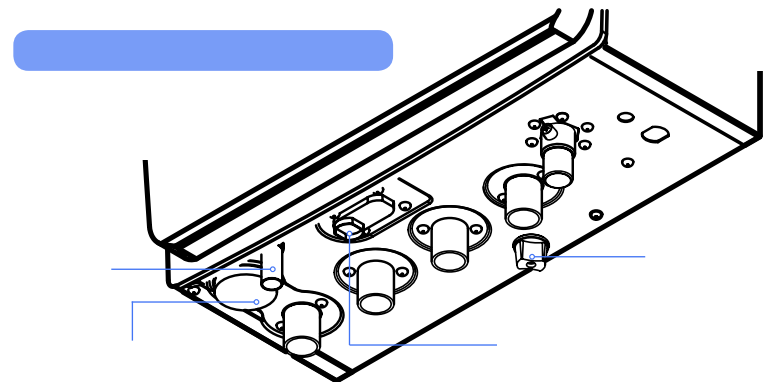



1.

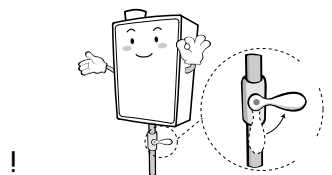

2.

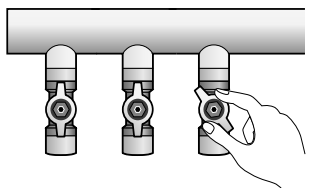

3.

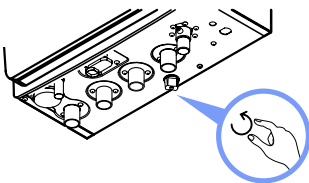

4.

"95",

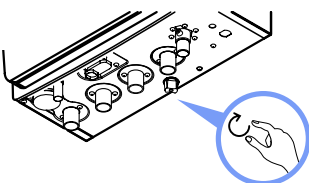

5.

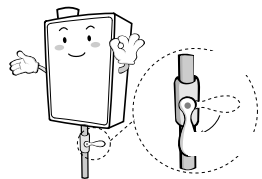

«At Home»

(« ») (CTR – 5700)

1.

At Home» (« »).

2.

« » ()/» » ()

3.

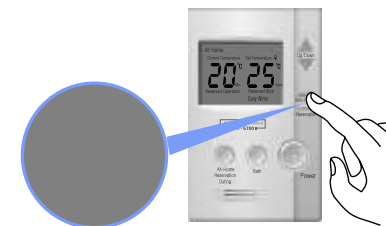
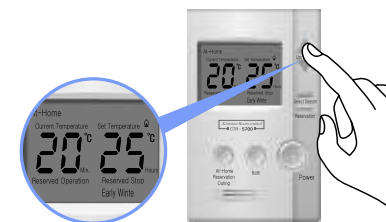
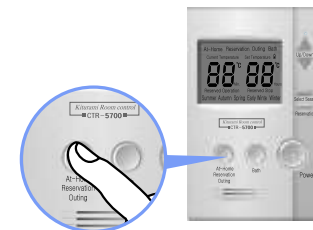

?

« » « ».

1- 45 , 2- 55 , 3- 65 , 4- 75 , 5- 80 .

«Reservation» (« »)

1. « »
 », «Reservation» (« »).
 (ON (« »))
 : 2, 20, ..

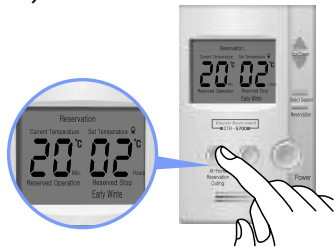

1. « » / « », Reserved Stop ().

2. () / « » (), Reserved Run ().

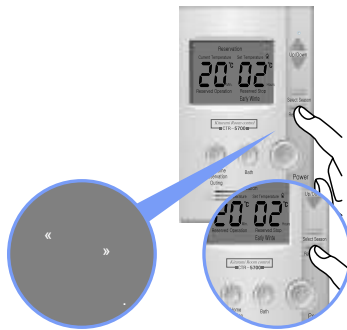

3. ()

«Outing»

1. () «Outing» «At Home/Reservation/Outing». ()

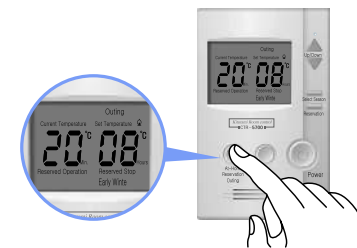

?

(ON)

?

10~15°C

- («DHW»)
- 1. «DHW» (), «DHW» [DHW].
- 2. 2,5 «DHW». (DHW)
- 3. «DHW», 78 ~ 147 (0,8~1,5).

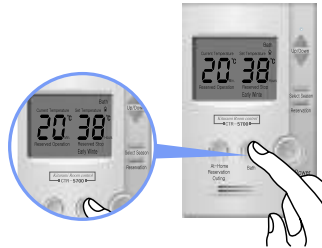

- ?
- 1. « », « » « » « » «DHW» ()



-
- 1. «DHW» (), «DHW».
- 2. « » () / « » ()
- 3. 35 60



15

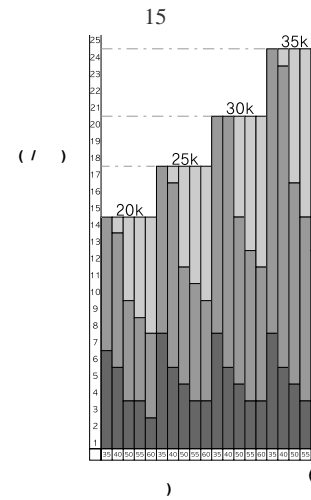
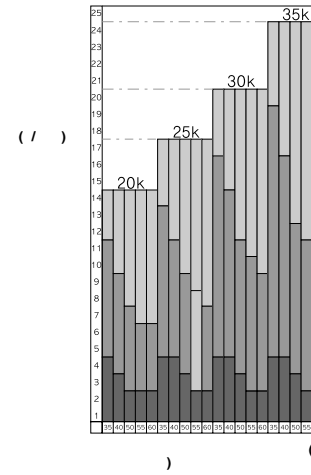

25

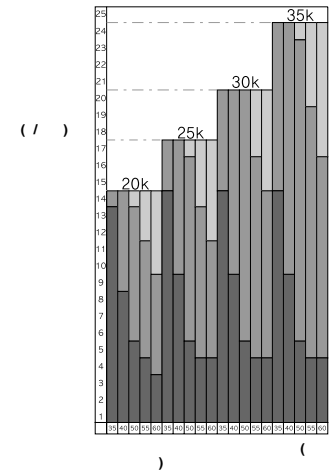

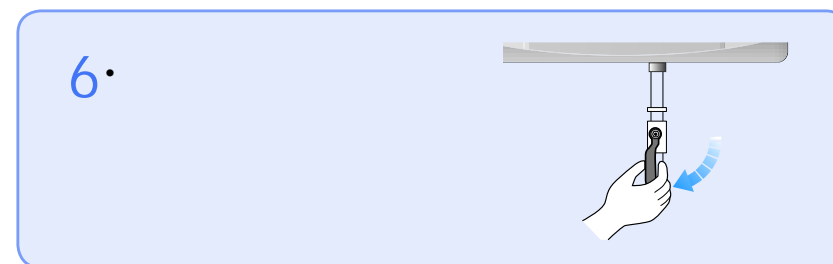
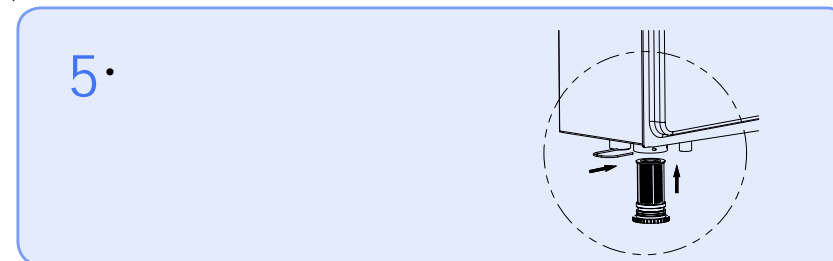
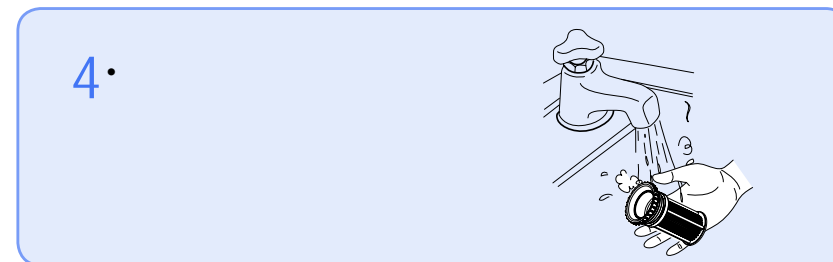
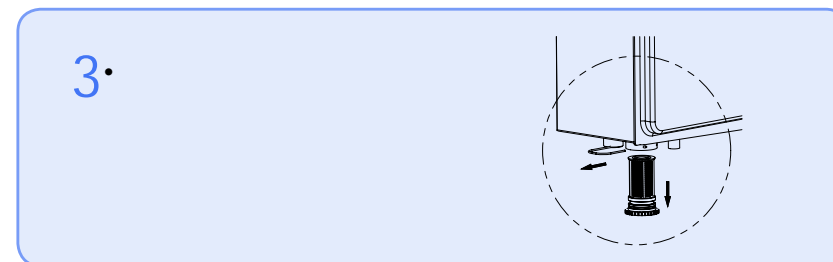
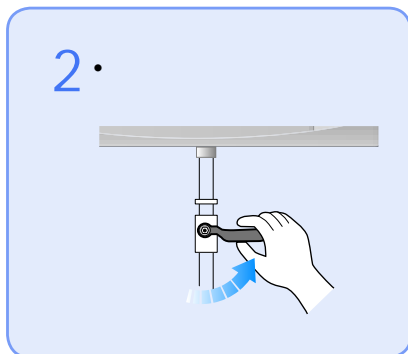
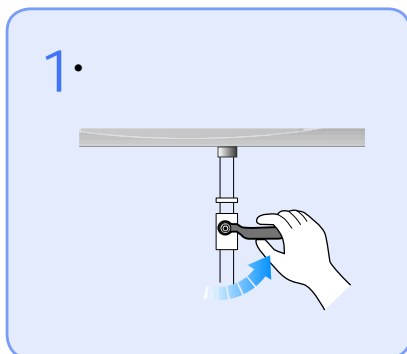



•

•

01 / 02 / 03 •

04 •

05 •



06 • /

07 •

08 • , / (10
230

95 •) (

96 • (. . 15-16)

97 • ? (97),



! :

5 ()

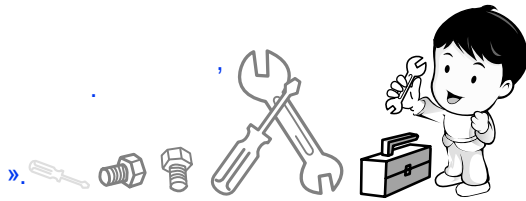

?



: :

60 40

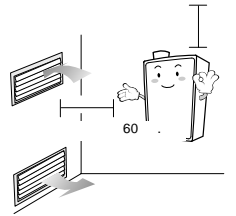

40

? FE (Forced Exhaust -)

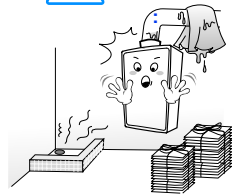

(CO)



!

1

(CO)

30

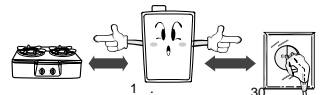

1

30

(, , , , . .)

– (FE)

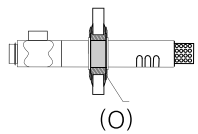
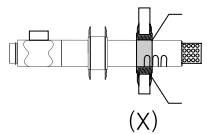
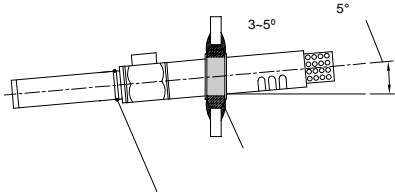
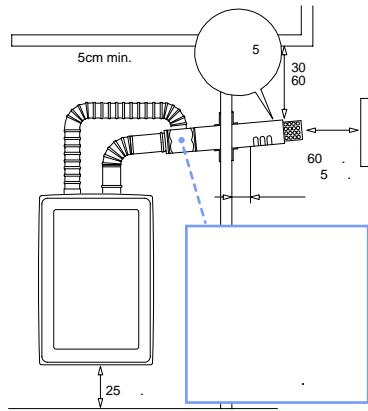

?

(FF)

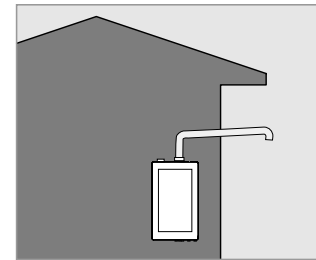

(X)

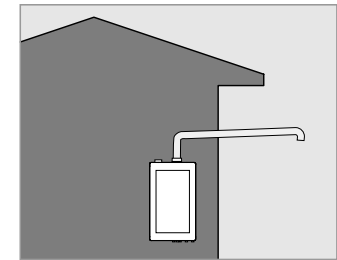

(O)

FF,

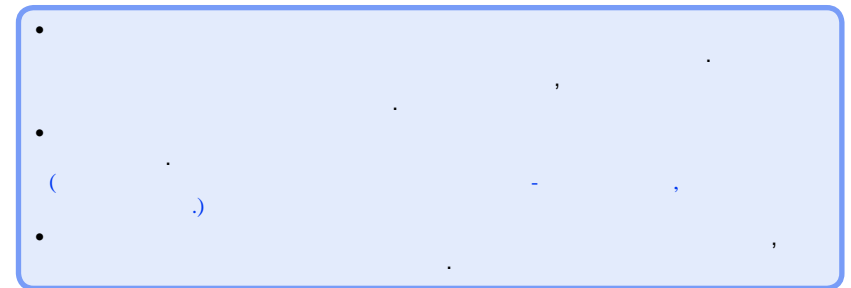

(FE)
FE (Forced Exhaust –)

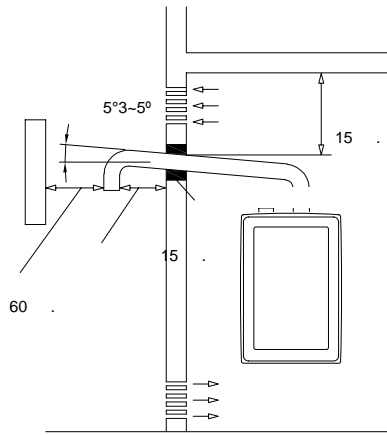

1,6
60

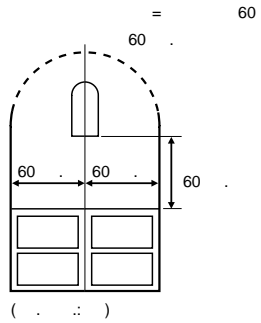

90°
(CO)

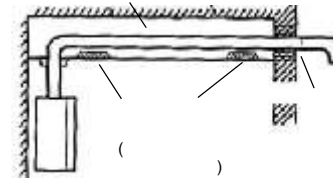

()

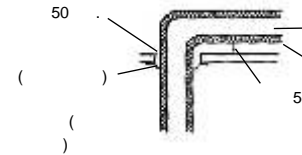

90

20



230 /50

230

230

230

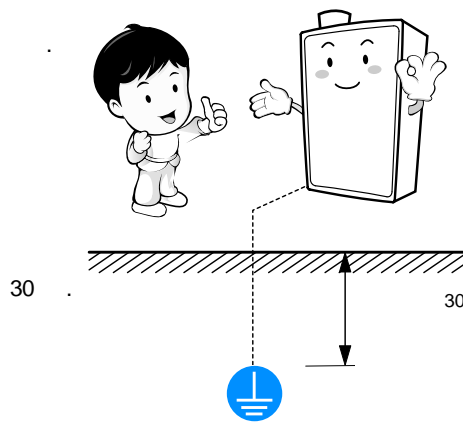

The gas pipeline must be constructed by a competent, qualified specialty contractor.

15A (PT 1/2)

(15A)

(29),

30

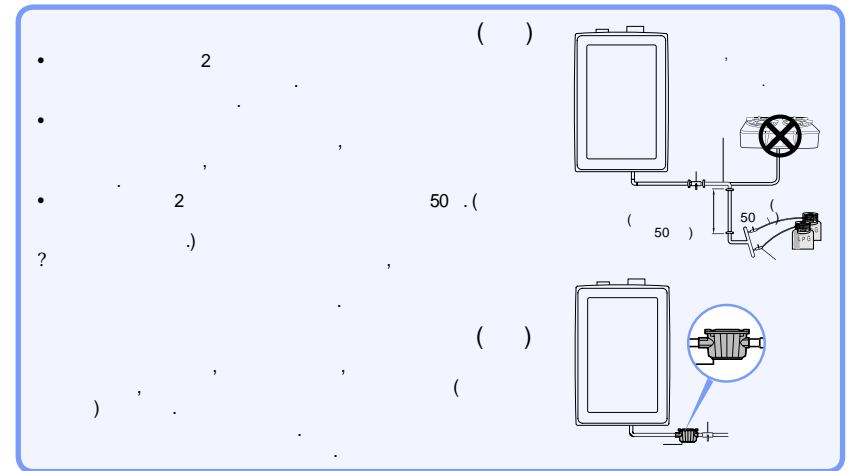
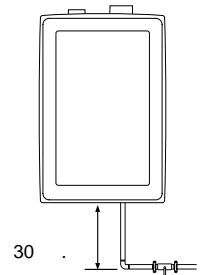

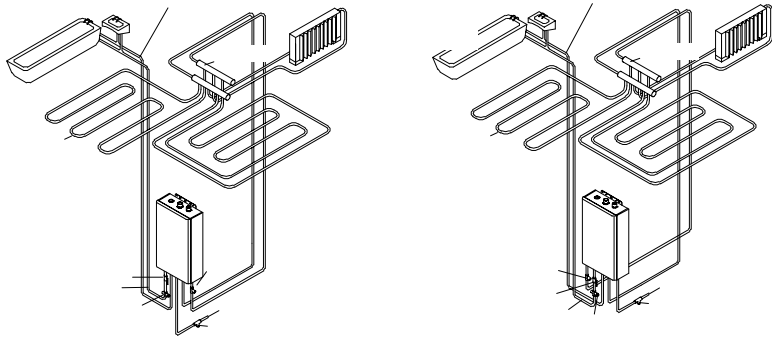
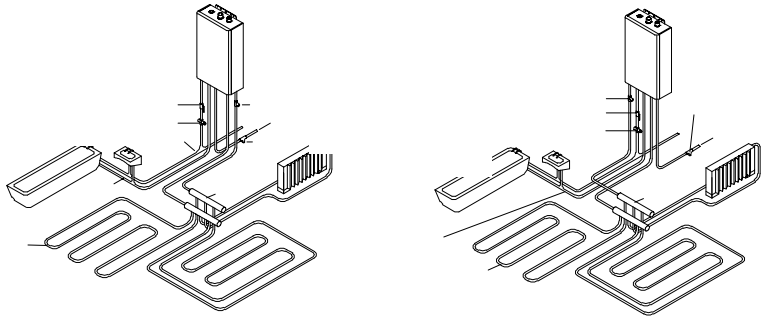

!



« »

2,5 /c 2,

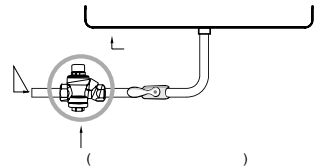

(

).



25

15A (PT 1/2)

1/100 ~ 1/200



15A (PT 1/2)



20A (PF 3/4)

36

44



()



13

8

)

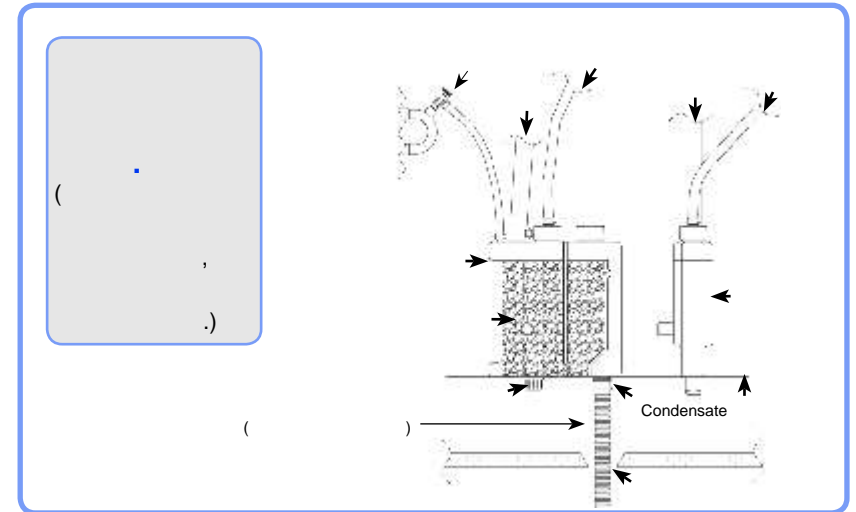



$$A = Q \times 0.6 \times K \times F = P$$

A: (2)
 Q: (/)
 K: [1]
 F: [2]
 P: (2)

1.0	1.3	1.4
-----	-----	-----

	1	2	3	4	5	6	7	8	9	10	11	12	13	14	15	16	17	18	19	20	21 or more
(F)	1.00	1.00	1.00	0.95	0.92	0.89	0.86	0.84	0.82	0.81	0.80	0.80	0.80	0.79	0.79	0.78	0.78	0.77	0.76	0.76	0.75

W:D 1:1.4

2

MOCIE, 08. 1998.

1

1.2 ~ 1.5

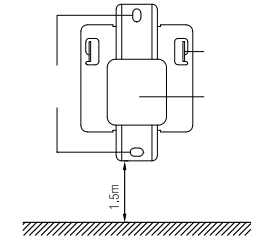

2

(CTR-5500).

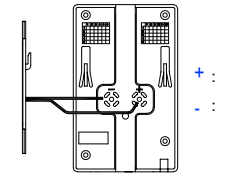

3

(CTR-5500)

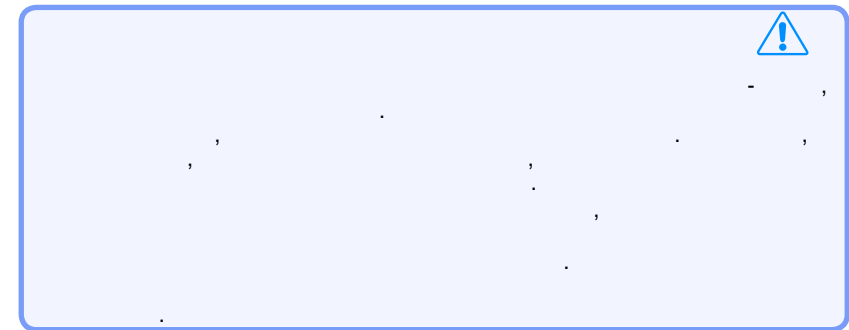
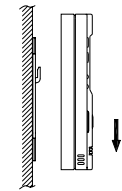



?

?

?

?

?

230 /50 ?

?

?



?

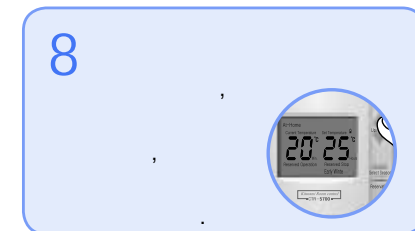
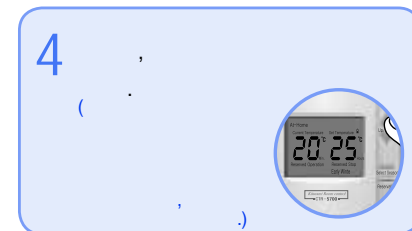
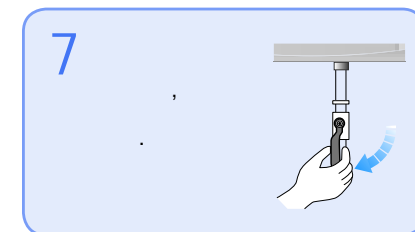
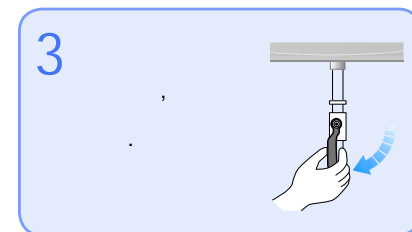
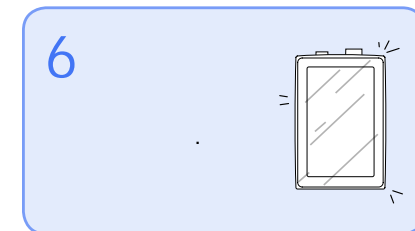
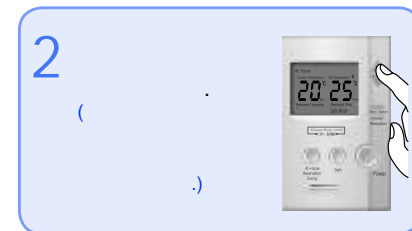
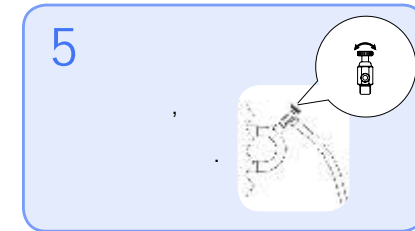
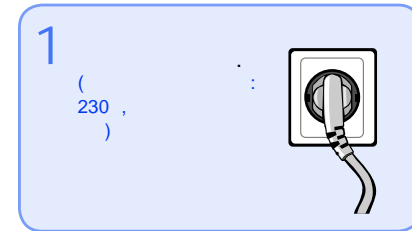

GTX-7000 ECO

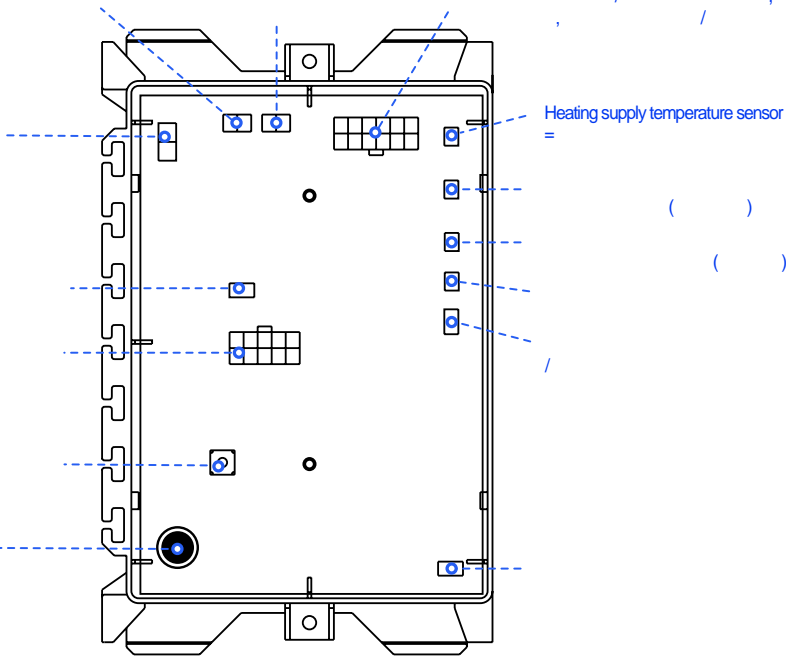

Mode Setting			Switch Position
Boiler Capacity Setting	(See the table on the right)		
LPG/LNG	LPG	LNG	2
Closed/open type	Closed type	Open type	3
FE/FF	FE	FF	4
Condensing/General Type	Condensing Type	General Type	5
Forced MIN Combustion	MIN Combustion	Normal Combustion	6
Forced MAX Combustion	MAX Combustion	Normal Combustion	7
			8
			9

Boiler capacity setting

Boiler Capacity	Switch Position		
	1	2	3
16000kcal	ON	OFF	OFF
20000kcal	ON	ON	OFF
25000kcal	OFF	OFF	ON
30000kcal	ON	OFF	ON
35000kcal	OFF	ON	ON

		EEO Condensing-16H		EEO Condensing-20H		EEO Condensing-25H		EEO Condensing-30H		EEO Condensing-35H			
		LNG(13A)	LPG	LNG(13A)	LPG	LNG(13A)	LPG	LNG(13A)	LPG	LNG(13A)	LPG		
		18.6		23.3		29.1		34.9		40.7			
		/	16,000	/	20,000	/	25,000	/	30,000	/	35,000		
	t +40°C	/	6.7	/	8.3	/	10.4	/	12.5	/	13.8		
		9.9 ~ 18.6		11.6 ~ 23.3		16.3 ~ 29.1		16.3 ~ 34.9		16.3 ~ 40.7			
		/	8,500 ~ 16,000	/	10,000 ~ 20,000	/	14,000 ~ 25,000	/	14,000 ~ 30,000	/	14,000 ~ 35,000		
FE	(%)	88.3/97.8	88.9/96.5	87.1/96.4	89.7/97.4	88.1/97.5	88.3/95.9	88.0/97.4	89.4/97.1	88.9/98.4			
		95.1/105.3	97.3/105.7	96.4/106.7	97.2/105.6	95.6/105.8	96.5/104.8	96.0/106.3	96.6/104.9	98.3/108.8			
		92.5/102.4	91.0/98.8	88.9/98.4	91.4/99.3	91.4/101.2	89.3/97.0	92.7/102.6	89.7/97.4	91.2/101.0			
		88.3/97.8	88.1/95.7										
		96.7/107.1	96.4/104.7										
		88.7/98.2	89.7/97.4										
		19.8		26.5		31.4		36.6		44.2			
		/	17,000	1.42	22,800	1.90	27,000	2.25	31,500	2.63	38,000		
		110		120		130		140		140			
		(LNG, 13A)/LPG											
	(H ₂ O)	(LNG, 13A)/LPG: 2.75±0.5 (280±50)											
		15											
		15											
		20											
		,mm											
		70 /		75		5		10					
		78-147 (0.8-1.5)											
	(/ 2)	98(1.0)											
	x x	486 X 220 X 730											
		37				43							
		35°C-60°C, 1.											
		: 45°C-85°C / 10°C-45°C 10°C-45°C											
		220 X 60											



		EOO Condensing -16D	EOO Condensing -20	EOO Condensing -25D	EOO Condensing -30D	-
	/	-19.8(17,000)	26.5(22,800)	-31.4(27,000)	36.6(31,500)-	-
	/	9.9-16.2 (8,500-14,000)	11.6-20.9 (10,000-18,000)	16.3-26.7 (14,000-23,000)	16.3-31.4 (14,000-27,000)	-
	%	97.8	96.4	97.5	10.63	-
	%	105.3	106.7	105.8	-106.3	-
		5				
	(H2O)	G20/LNG:20(200)				
		2.5				
		85				
		45-85				
		7				
	(/)	9.9-1806 (8,500-16,000)	11.6-23.3 (10,000-20,000)	16.3-29.1 (14,000-25,000)	16.3-24.9 (14,000-30,000)	-
		2.5				
		0.8				
		10				
	4t=25 /	10.7	13.3	16.7	20	-
	4t=40 /	6.7	8.3	10.4	12.5	-
		230,50 60				
	W	130	130	140	140	-
		B23-C12-C32-C42-C52-C62-C82				
		60/100, 80/80				
	~ :	15				
	:	20				
	:	15				
	(x) x	486x220x730				
		26	28	30	35	-
		G2,LNG				



Kiturami



Kiturami



Kiturami